



# External Transmission Oil Cooler Kit

## Suitable for:



**Ford Ranger NextGEN  
Ranger Raptor**

**WITH THE FOLLOWING ENGINES:**

**V6 3.0L Twin-Turbo ECOBoost - 2022 to Present**

Please read through all of the instructions carefully before proceeding. If any of the information does not appear correct or the diagrams don't match your vehicle, please contact Driveline on +61 08 9443 2211.

# Parts List

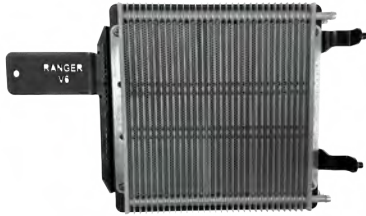

1 x Dual Cross Flow Oil Coolers Pre-Mounted



2 x 1/2" Barbed Joiners



4m x 1/2" High Temp Cooler Line Hose

---



500mm of 1/2" Cooler Joining Hose



1 x Plate with Nutsert



8 x 12-20 Hose Clamps

---



3 x M6 x 20 SEMS Bolts



6 x 300mm Cable Ties

---

Expected Installation Time: 3 Hours

## Summary of Installation - For Experienced Fitters

- SAFETY FIRST: Allow engine, auto and fluid to cool prior to starting work to prevent serious injury.
- Remove the top cover from over the radiator.
- Using a T30 Torx bit, remove the screw holding the inlet manifold to allow you to easily remove and reinstall the cover.
- You need to remove the trim at the bottom of the front grill to expose the bolts holding the front grill in place.
- Use an 8mm socket to remove the 3 bolts that hold the bottom of the grill in place
- Remove the two bolts that secure the top of the grill
- Disconnect Water feed and camera plug before removing the grill
- Remove the small panel on the drivers side, remove the trim clip indicated as 1. in the image below. Then remove the 10mm head bolt indicated as 2. In the corner of the panel indicated as point 3. in the above image, drill a hole that is at least 20mm in diameter. This allows the panel to be refitted once the drivers side mounting bolt is in place. (SEE PAGE 9 FOR DETAIL)
- Insert cooler and secure using M6 bolts supplied. A Nutsert is provided for the drivers side.
- Route hoses to the factory oil cooler
- Cut drivers side return line and connect cooler hoses using supplied barbs and hose clamps (see page 15 and 16)
- Check clearance of hoses and fittings to any other moving/hot part. If needed, top up engine coolant and/or transmission fluid with the recommended fluid
- Test drive vehicle for 15mins and then check all hoses and fittings for leaks and also check mounts and bolts are tight. Clean any oil or coolant residue off vehicle. Road test. Check for leaks. Re-tighten if necessary. Re-check fluid levels.
- Refit any bash plates, grills, aftermarket accessories removed.

## Detailed Installation Instructions

Before Commencing work, please ensure that you have sufficient transmission fluid to top up at the end of the job. Please read through all of the instructions to familiarize yourself with the process first.

1. Open Bonnet.
2. Remove the top cover above the radiator. There are 13 plugs that need to be removed as shown below. Unscrew the center from the plug body.



- Using a T30 Torx bit, remove the screw holding the air inlet manifold to allow you to easily remove and reinstall the radiator cover.

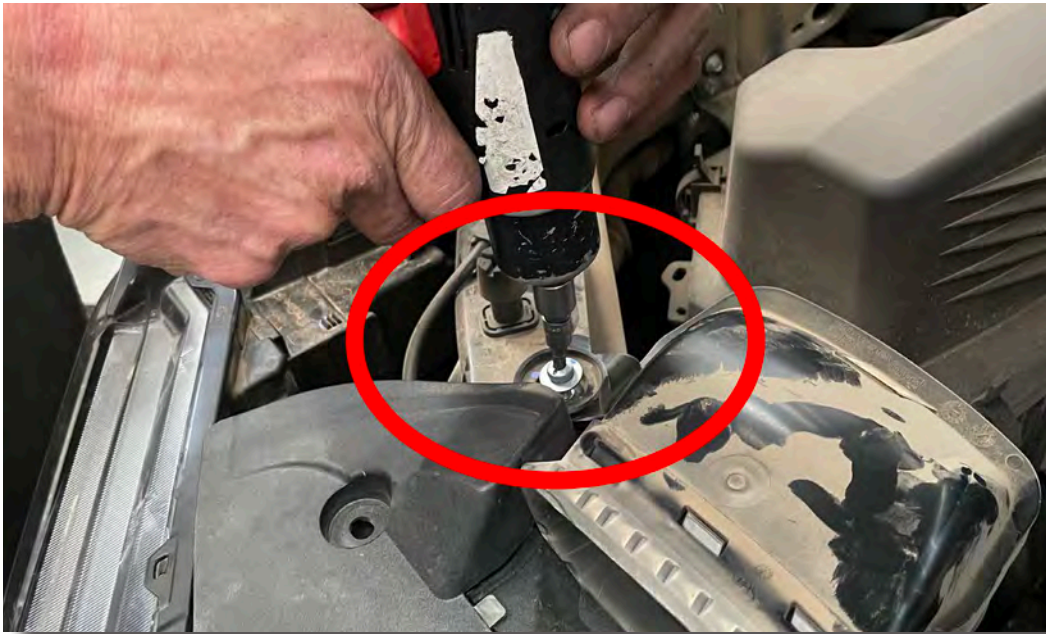

- You need to remove the trim along the base of the front grill to expose the bolts holding the grill in place. This is a delicate process and care needs to be taken to ensure the clips are not broken.

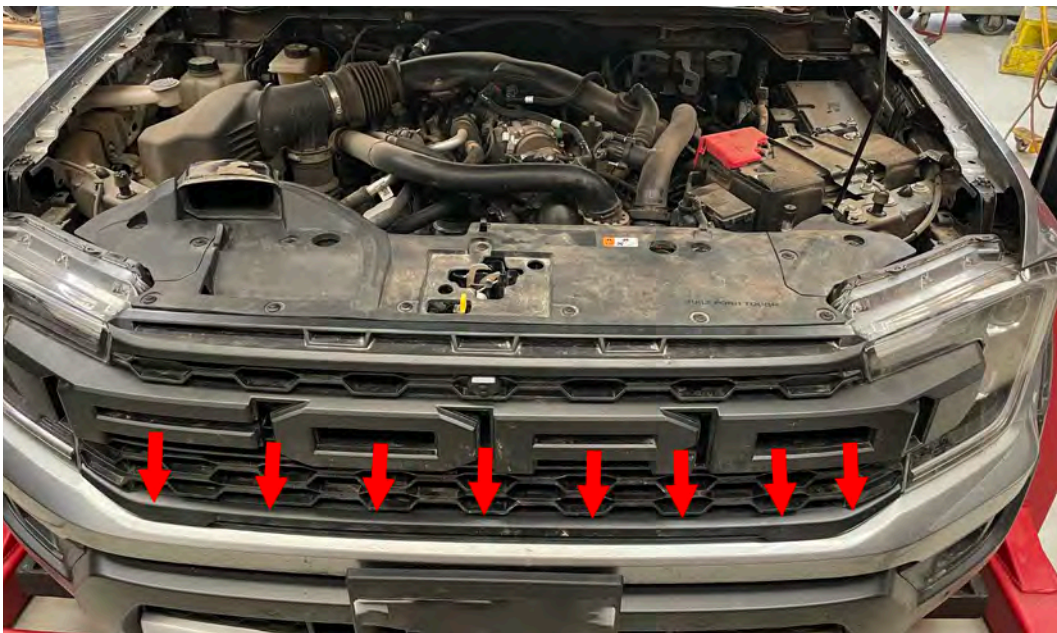

5. We recommend using masking tape on the bumper to avoid scratches.



6. Carefully lever the trim forward to release the clips. Work your way slowly along the trim to pop the clips forward.



7. With the trim out of the way, use an 8mm socket to remove the 3 bolts that hold the bottom of the grill in place.



8. Again with the 8mm socket, remove the two bolts that secure the top of the grill as shown

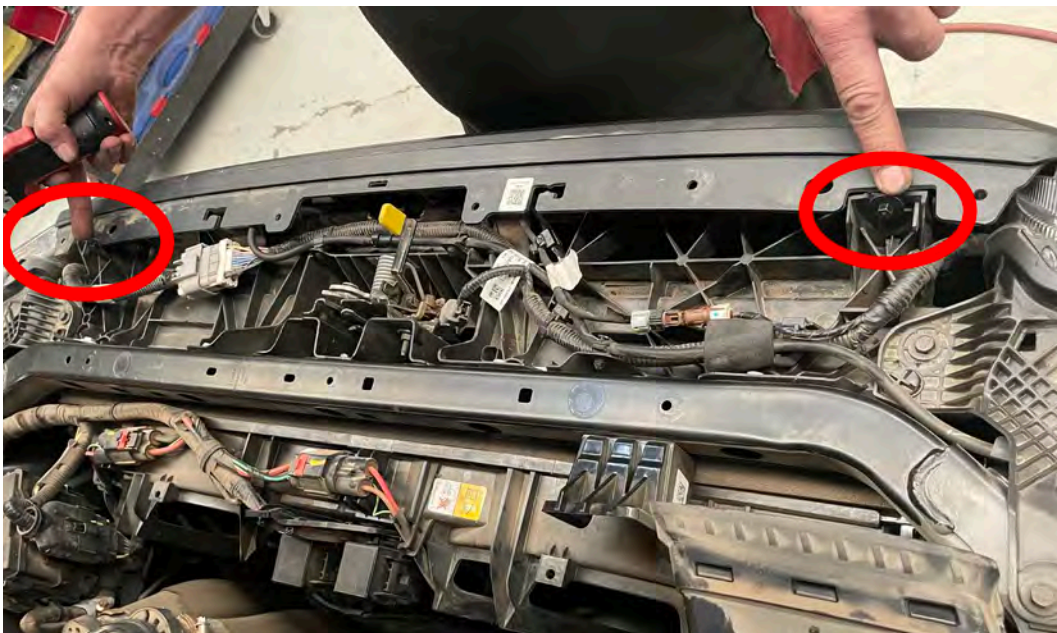

9. Two plugs will need to be disconnected before the grill can be removed. Note that the black plug indicated is a water pipe supplying washer water to the front camera. Position it so water does not drain while disconnected.

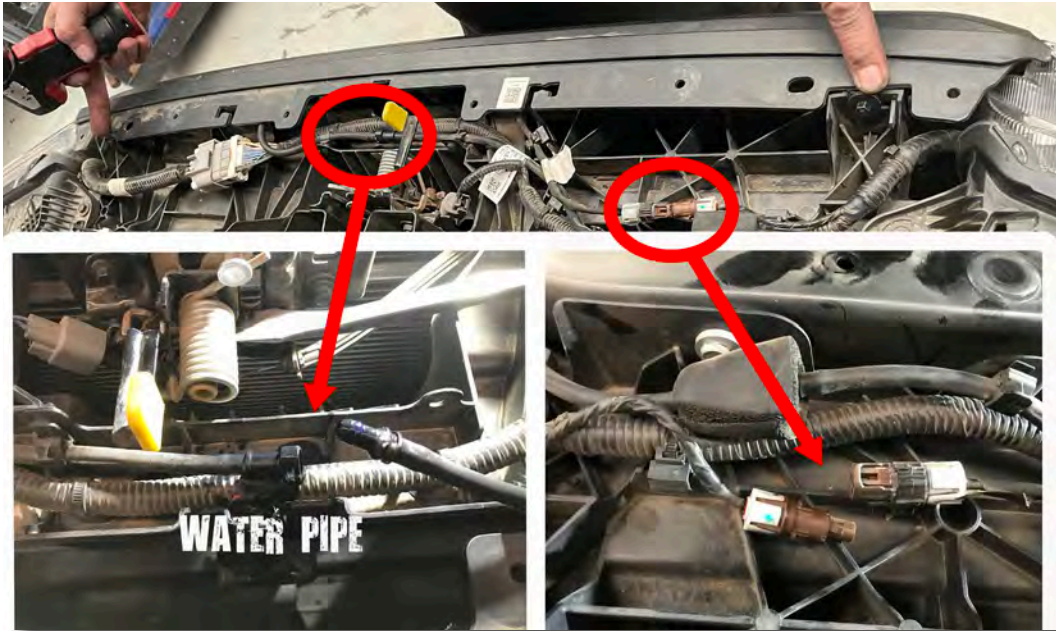

10. Gently pull forward on the grill to remove and place safely out of the way.

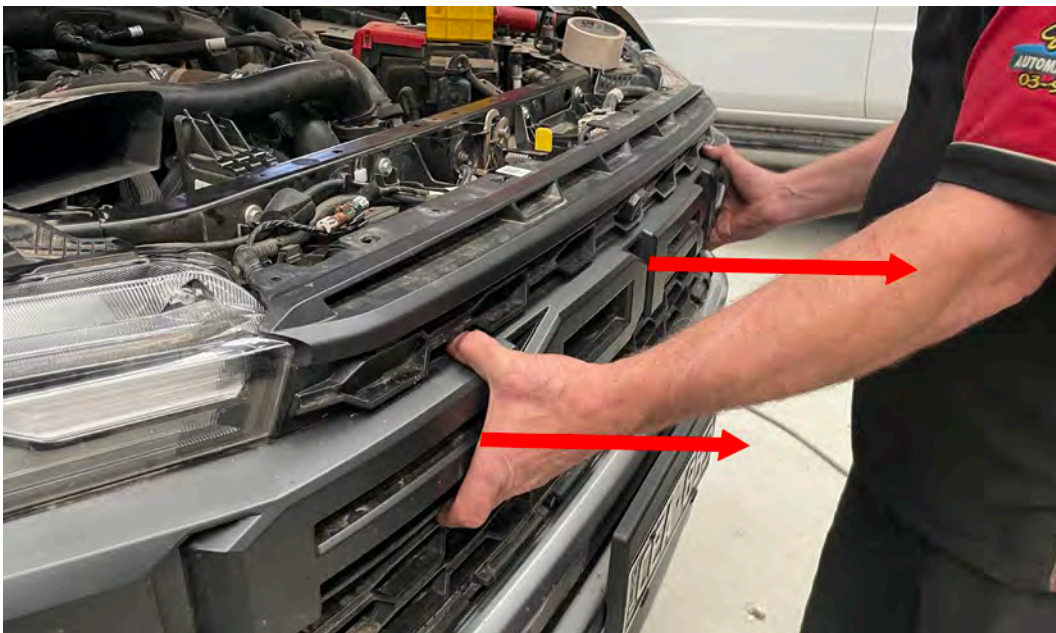



11. Remove the small plastic panel on the drivers side. First remove the trim clip indicated as 1. in the image below. Then remove the 10mm head bolt indicated as 2.

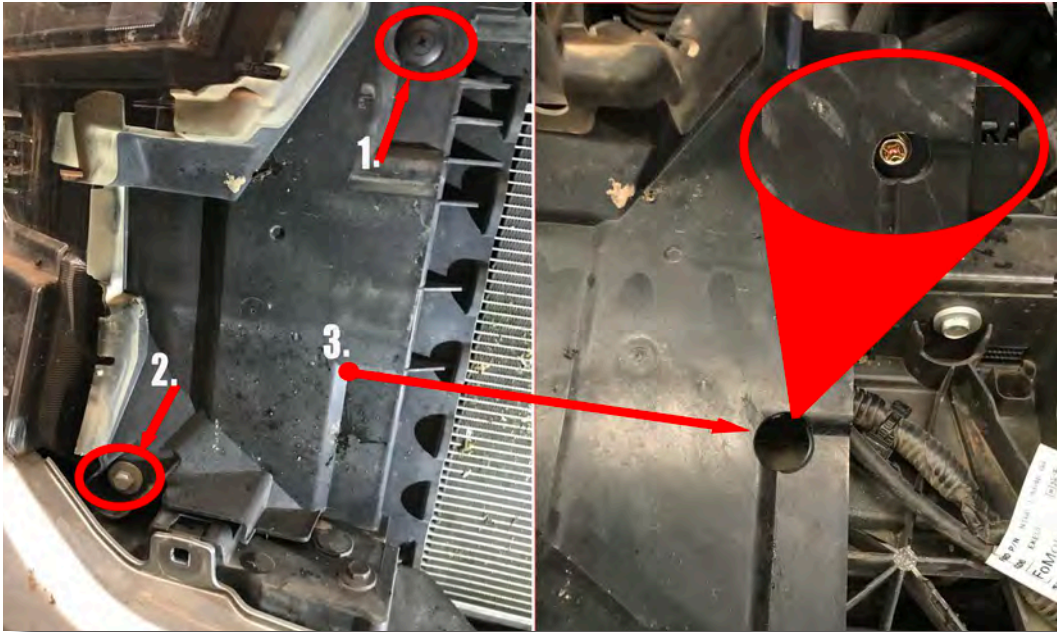

In the recessed corner of the panel indicated as point 3. in the above image, drill a hole that is at least 20mm in diameter. This allows the panel to be refitted once the drivers side mounting bolt is in place.

12. Remove the 4 bolts holding the bash plate under the front of the vehicle and place safely out of the way.

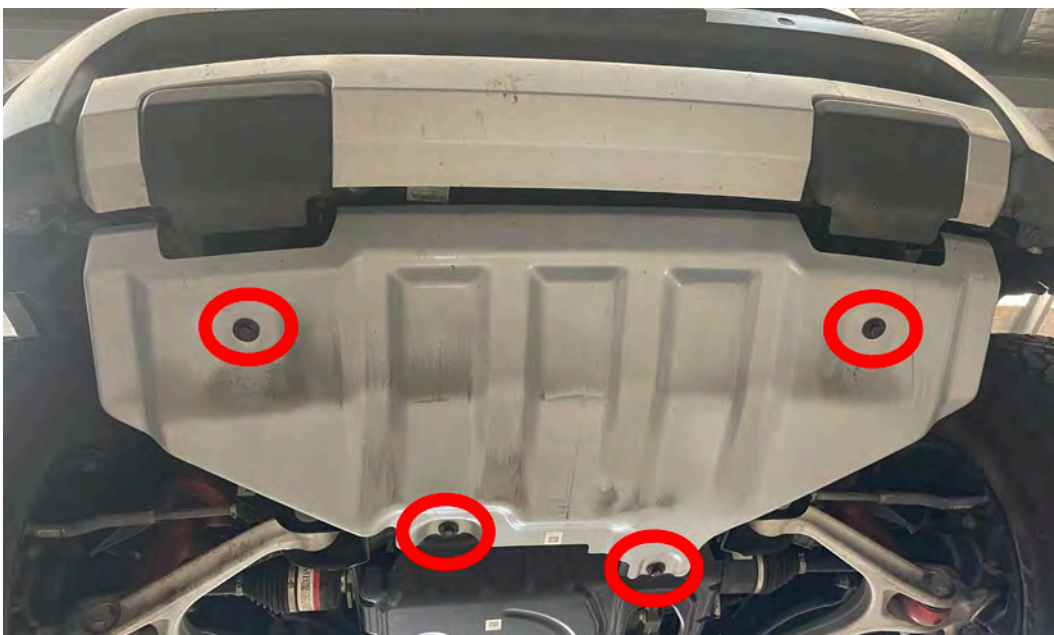

13. Remove the Cooler from the packaging and place on a flat bench. Connect the 500mm joining hose to the bottom barb of the front cooler and the other to the top barb of the rear cooler. Secure with hose clamps supplied.

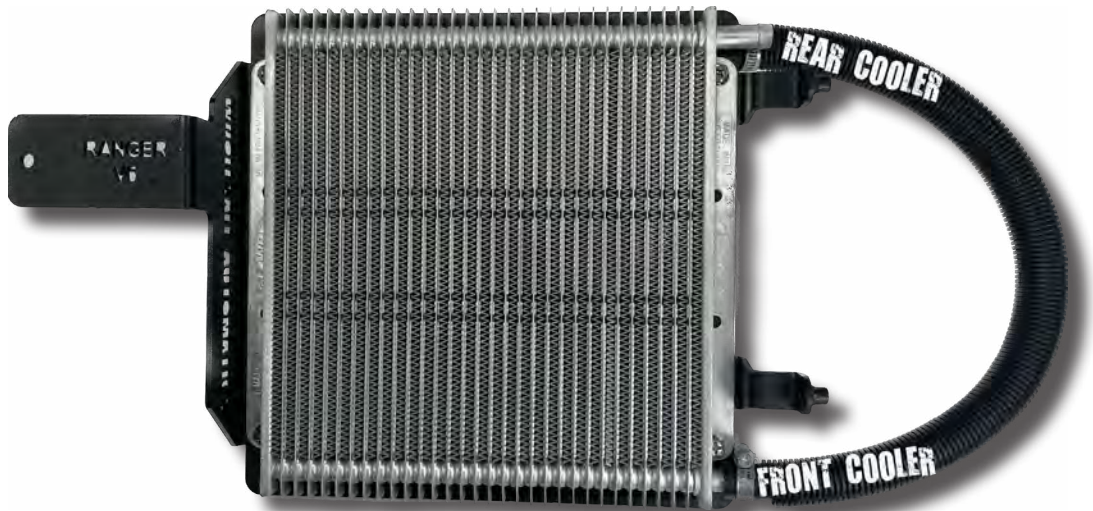

Coolers are omni-directional, so the direction of flow is not important, however we recommend for maximum efficiency that oil traverses the rear cooler before the front cooler.

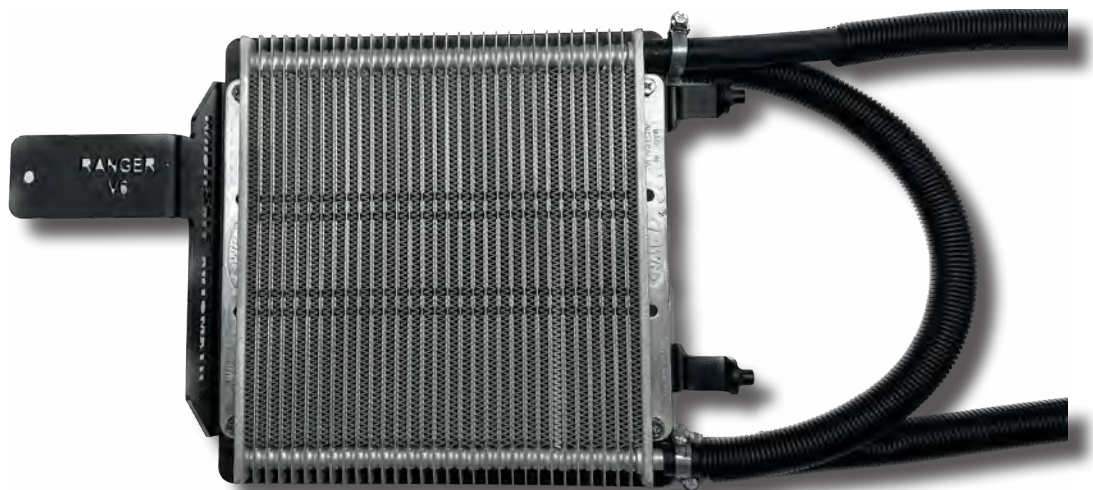

14. Connect the 4M hose to the remaining barbs and secure with the hose clamps provided. Cut the 4M length of hose in half.

15. Position the cooler in the vehicle with the hoses running behind the center support towards the passenger side.



16. Use one of the supplied M6 bolts to hold the cooler in place. Do not tighten.

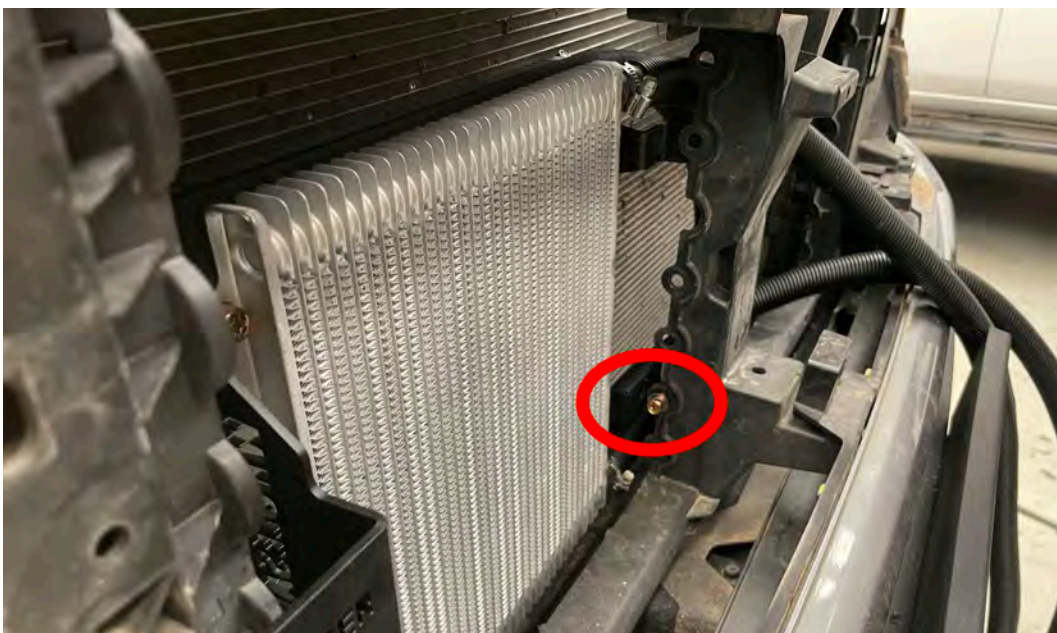

17. Use a supplied M6 bolt and the tab with the Nutsert to secure the drivers side mount to the vehicle.



18. Use remaining M6 bolt to secure the passenger side of the mount to the center support. Tighten all 3 bolts to secure the cooler mounting bracket.

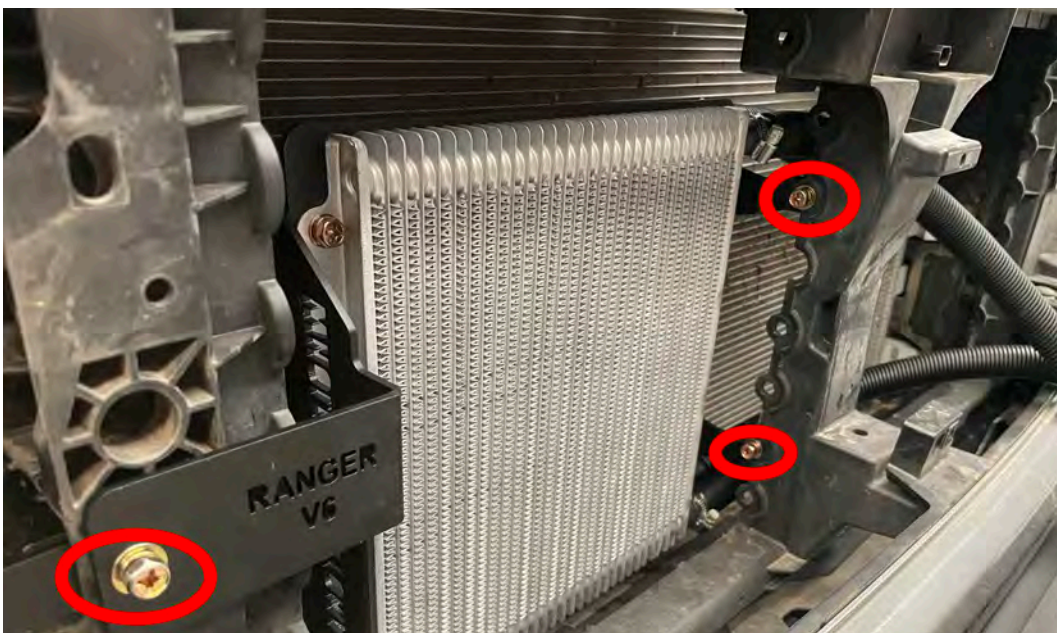

19. Due to the space available, it is easier to feed the hoses under the vehicle one at a time. Feed the first hose under the AC Condenser on the passenger side.



20. From under the car, locate the factory oil cooler in the center of the vehicle as per the photo below. This is the pipe we will be connecting to. Route the hose across to the factory oil cooler.





21. Route the second hose along the same path of the first hose.



22. Ensure both hoses are safe, clear of any moving parts and are free of any kinks that may restrict or impede the flow of transmission oil.



23. The drivers side pipe coming out of the factory oil cooler is the return line. Cut the hose in the 2 locations as indicated in the picture below and discard the unused hose.

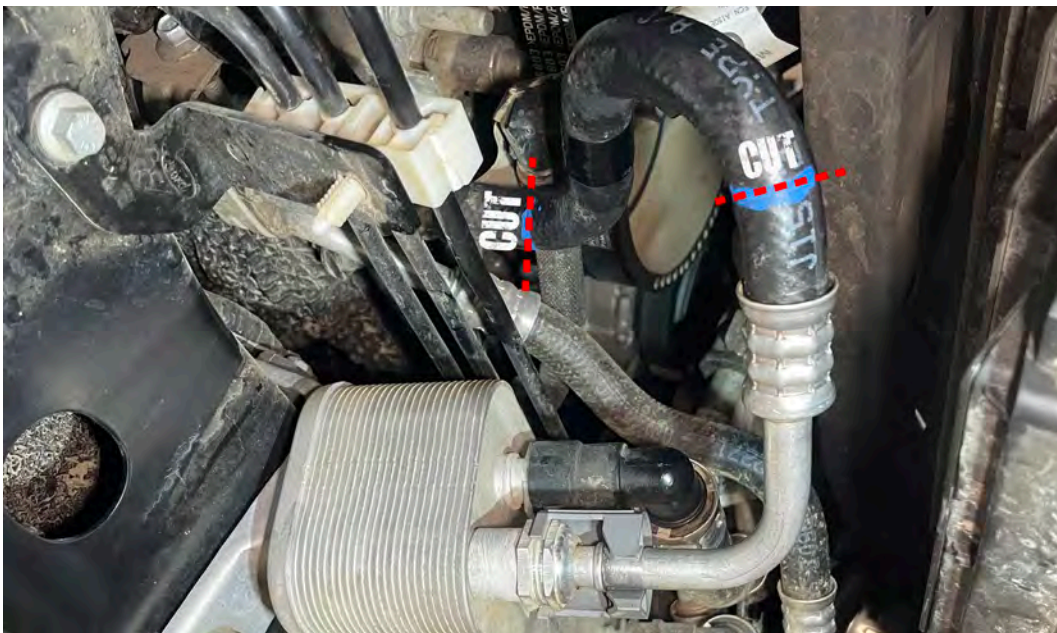

24. Rotate the return line pipe to point towards the passenger side of the vehicle.

25. Insert a gold barb into each end of the cut hose and secure with hose clamps supplied.

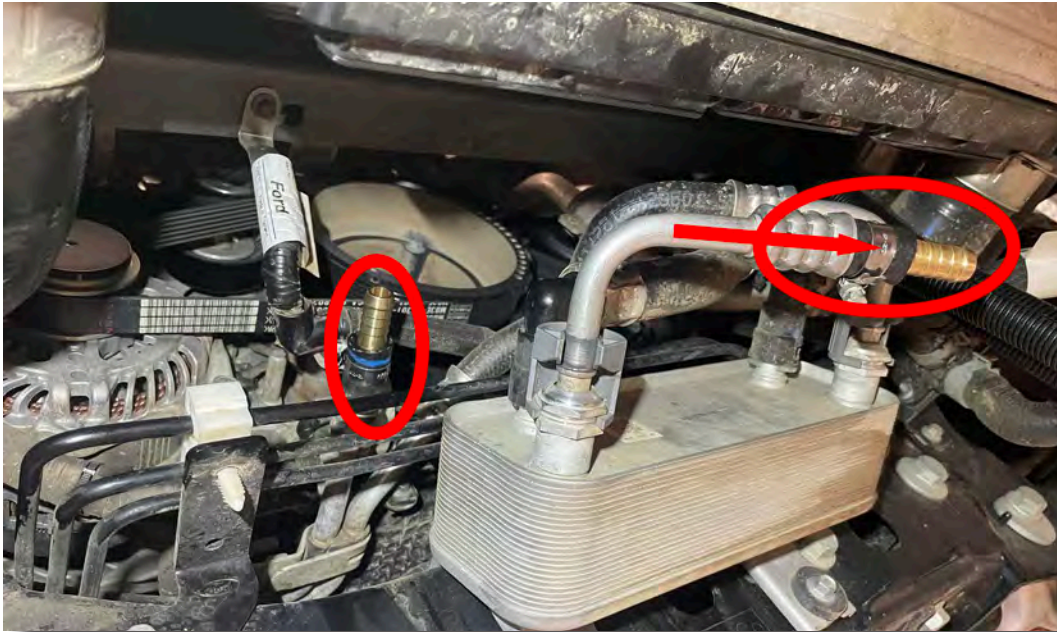

26. Connect the hose running from the rear cooler to the return line pipe coming out of the factory cooler, and the hose from the front cooler to the transmission return line. This will maximise the efficiency of the coolers. Secure both lines with hose clamps supplied





27. Using the cable ties provided, secure the cooler lines to eliminate movement and rubbing that may damage the hoses.



28. Reinstall the bash plate and secure with the 4 bolts previously removed.

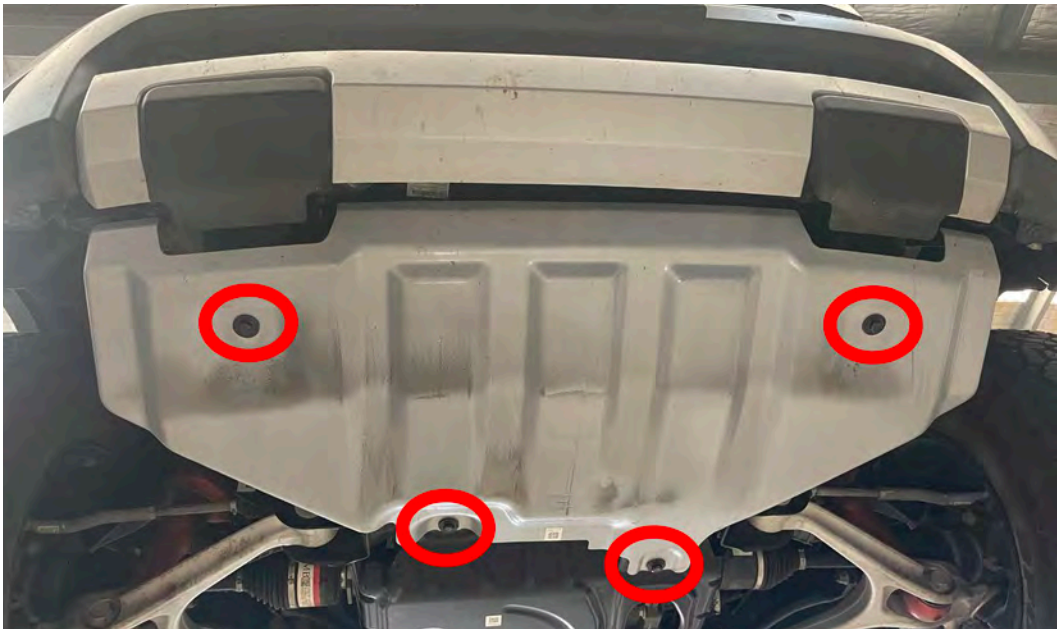

29. Reinstall the panel on the drivers side ensuring the hole cut is sufficient to clear the newly installed bolt head.

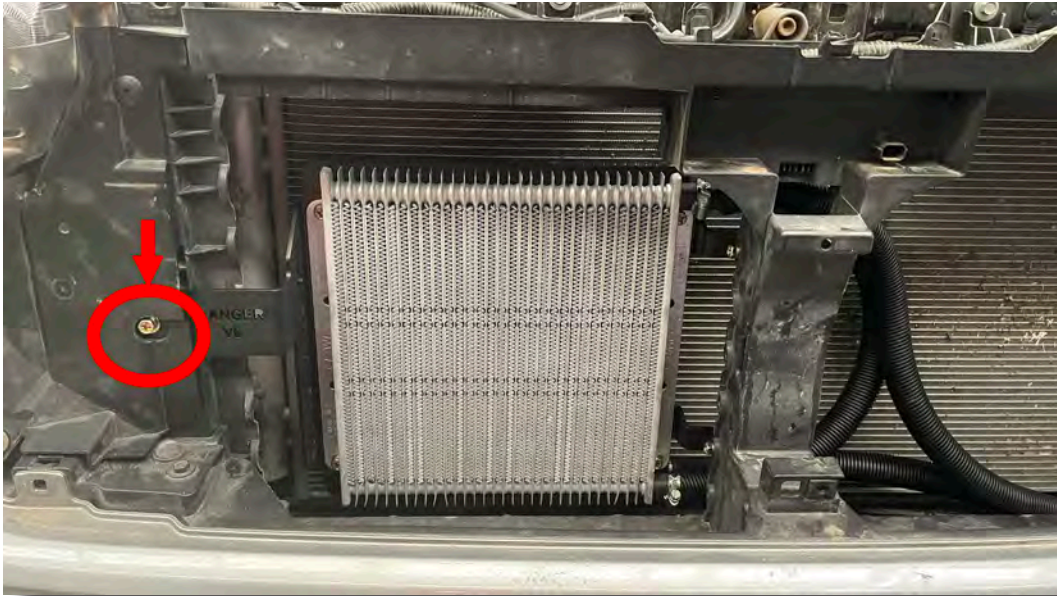

30. Reinstall the front grill and secure with the 5 bolts previously removed.

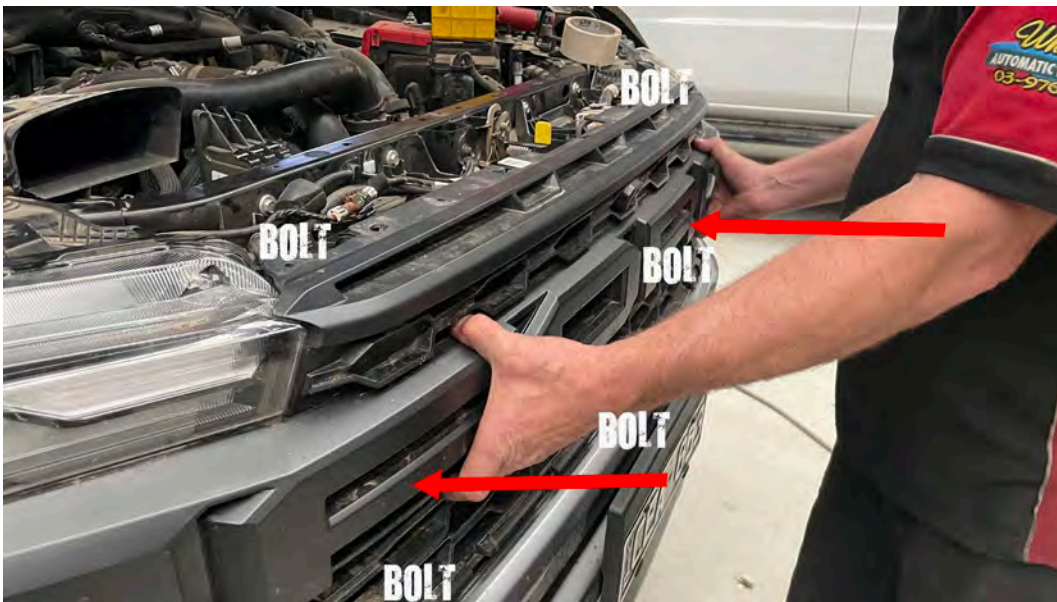

31. Reconnect the 2 plugs above the grill for the front facing camera and washer. Don't forget to top up the washer bottle!!

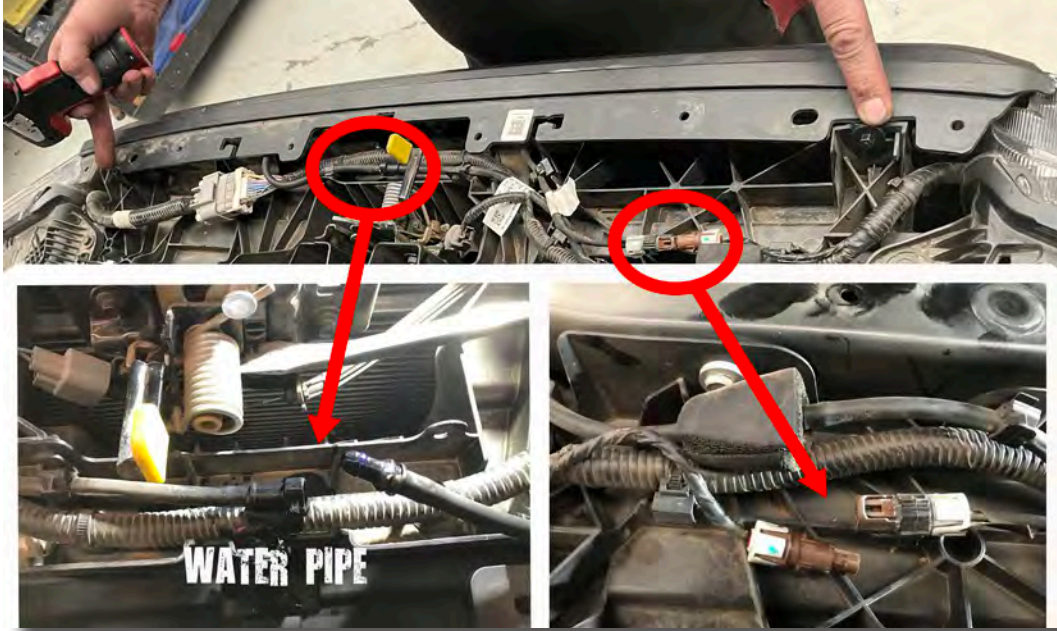

32. Push the trim back into place below the grill.



Masking tape used to protect the bar can now be removed and discarded.

33. Reinstall the top cover using the 13 clips previously removed and secure the air inlet using the T30 Torx bit.



34. Before test driving the vehicle ensure you check the transmission fluid level and if necessary, top up with Genuine Transmission Fluid or any full synthetic transmission fluid that meets or exceeds the genuine oil specification.
35. Road test vehicle for a minimum of 15 minutes. Try to find a couple of hills that will get the transmission to work hard.
36. Check the transmission coolers, fittings, hoses, unions, mountings and clamps for any leaking or loose fittings. Tighten if necessary.
37. Check engine coolant level and transmission fluid level again.

### ***FLUID FILL PLUG***

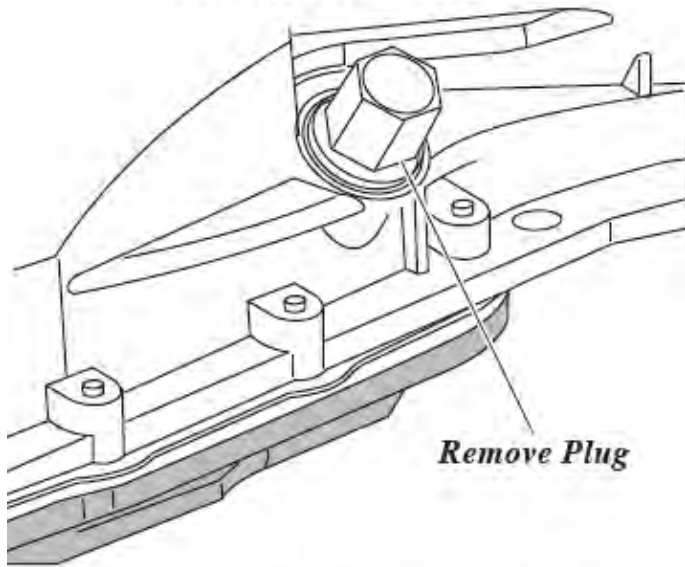

### ***FLUID LEVEL INDICATOR***

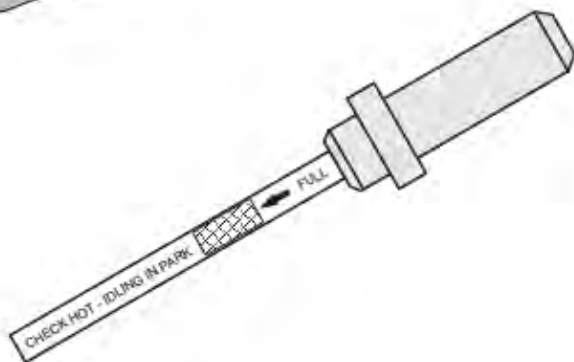
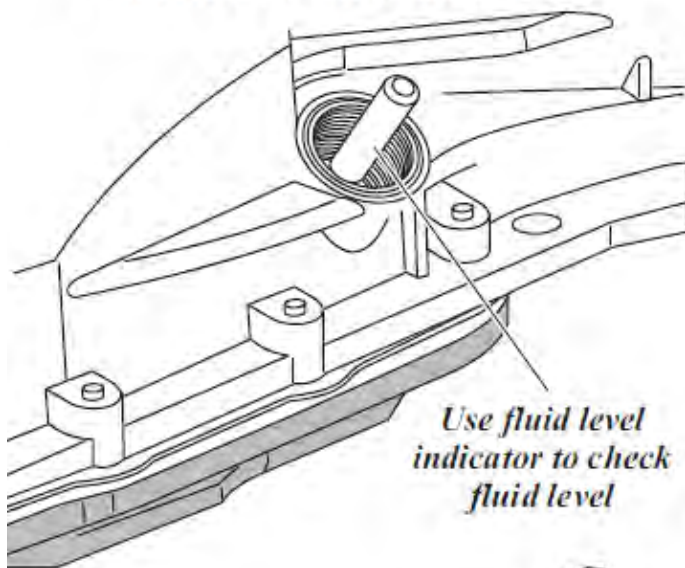

*Check fluid level hot idle in park*

**The recommended transmission fluid for Ford 10R60 10 Speed meets or exceeds the Mercon ULV<sup>®</sup> standard.**

# This completes the installation of the Dual Transmission Oil Cooler Kit: Ford Ranger NextGEN Raptor

Please remember ALL automatic transmissions have a service interval of 2 years or 40,000km to improve the longevity of the transmission.



