



Toyota/Lexus U760E, U760F ZIP KIT®

PART NUMBER **U760E-ZIP**

IDENTIFICATION GUIDE

Valve Body Identification Guide

U760E

Upper Valve Body Casting

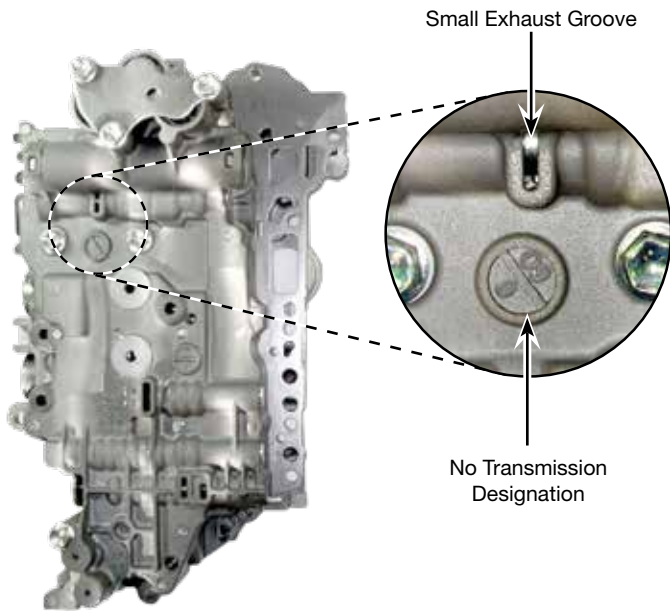

Solenoid Casting

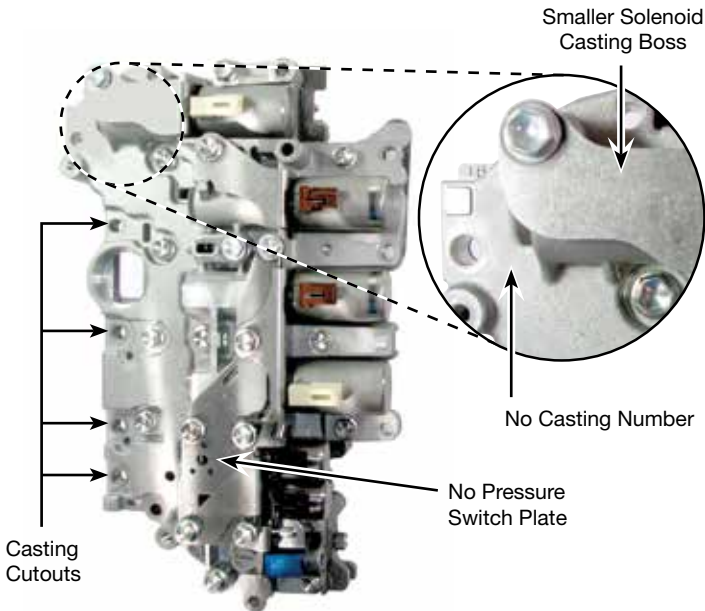

NOTE: Large canister solenoid connectors are brown and white.

U660E, U660F

Upper Valve Body Casting

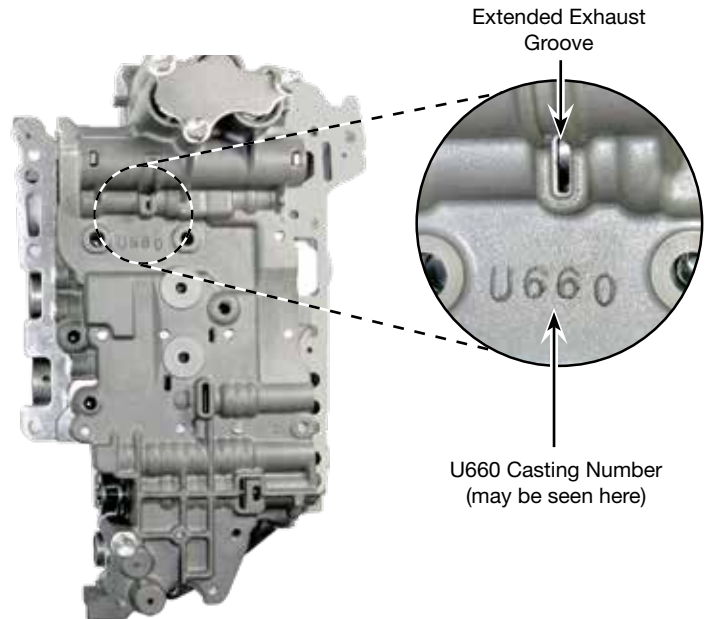

Solenoid Casting

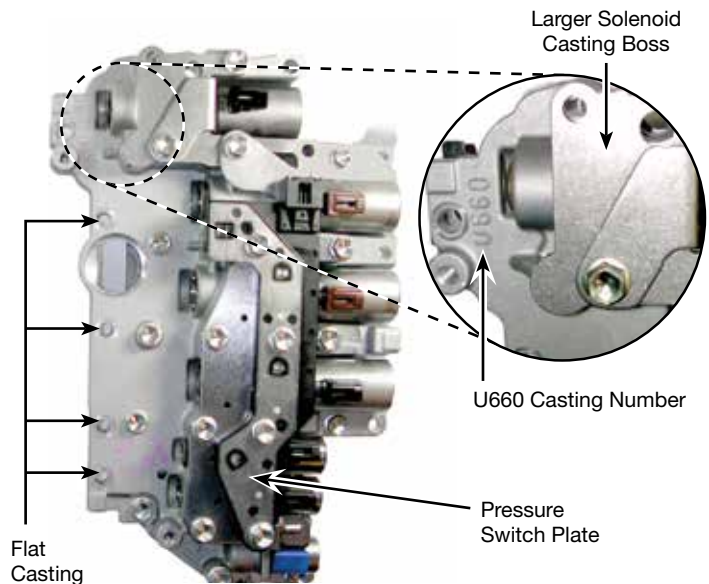

NOTE: Large canister solenoid connectors are brown and black.



Toyota/Lexus U760E, U760F ZIP KIT®

PART NUMBER U760E-ZIP

QUICK GUIDE

Parts are labeled here in order of installation. See other side of sheet for details on kit contents.

INSTALLATION DIAGRAM

Middle Valve Body
U760E Shown

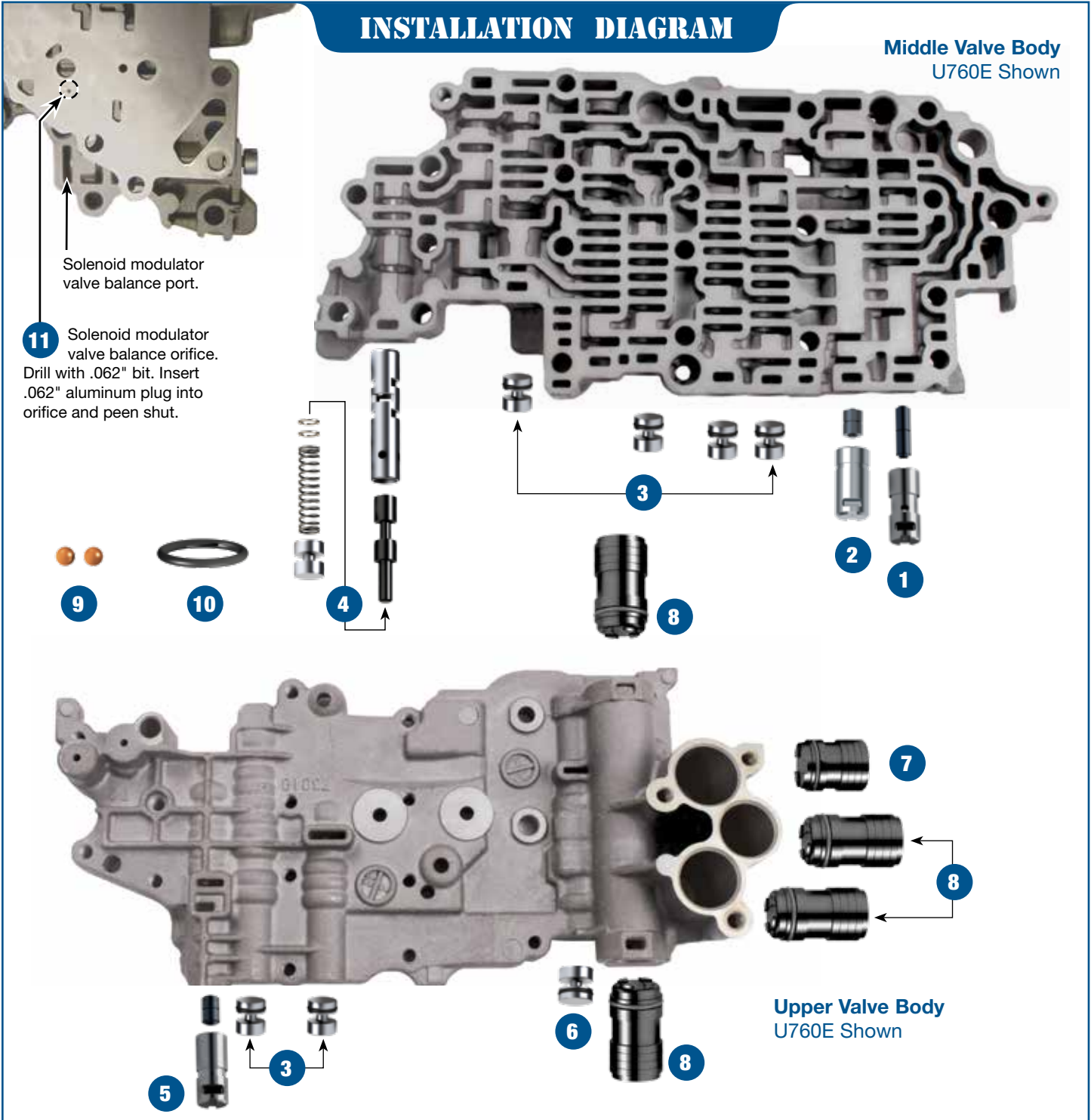

In addition to general rebuilding tips and technical information, the technical booklet included in this kit contains vacuum testing and additional repair options for higher mileage units or for repairing specific complaints which are beyond the scope of this kit.

Kit Contents & Installation Steps

Step 1 Replace OE B1 Apply Boost Assembly

Packaging Pocket 1

- Sleeve
- Valve

Step 2 Replace OE Reverse Boost Assembly

Packaging Pocket 2

- Sleeve
- Valve

Step 3 Replace OE Small End Plugs



CAUTION! O-rings go on inboard spool! Inboard retaining port edge on casting should be chamfered prior to installation to prevent O-ring shear. See page 8 of installation and testing booklet for details.

Packaging Pocket 3

- End Plugs, Small (6)
- O-Rings, Small (9) 3 extra

Step 4 Replace OE Solenoid Modulator Valve LineUp



CAUTION! Note location of OE retainer on tri-lobed OE end plug, if applicable. See page 8 of installation and testing booklet for assembly details.

Packaging Pocket 4

- Valve
- Sleeve
- Spring
- End Plug
- Shims (2)

Step 5 Replace OE Lockup Control Boost Assembly

Packaging Pocket 5

- Sleeve
- Valve

Step 6 Replace OE Large End Plug



CAUTION! O-ring for this large end plug goes on outboard spool!

Packaging Pocket 6

- End Plug, Large
- O-Rings, Large (2) 1 extra

Step 7 Replace OE (Short) C1 Accumulator Piston

Packaging Pocket 7

- Accumulator Piston
- O-Rings (2) 1 extra

Step 8 Replace OE (Long) B1, B2, B3 & C2 Accumulator Pistons

Packaging Pocket 8

- Accumulator Pistons (4)
- O-Rings (6) 2 extra

Step 9 Replace OE Checkballs

NOTE: See pages 6 & 7 in installation and testing booklet for locations.

Packaging Pocket 9

- Checkballs, .218" dia. (2)

Step 10 Replace OE O-Rings on Case Connector

NOTE: See page 8 in installation and testing booklet for locations.

Packaging Pocket 10

- Case Connector O-Ring, Large

Step 11 Drill & Plug Separator Plate Balance Orifice at Solenoid Modulator Valve

To prevent solenoid modulator leakage, drill indicated orifice to .062". Plug with aluminum plug and peen in place.

Packaging Pocket 11

- Orifice Plugs, .062" dia. (2) 1 extra
- Drill Bit, .062" dia.



Toyota/Lexus U760E, U760F ZIP KIT®

PART NUMBER U760E-ZIP

INSTALLATION & TESTING BOOKLET

TCM Initialized/Memory Reset

The U760E and U760F TCM learns the performance of the vehicle and adapts the transmission accordingly. When significant transmission or engine repairs are made, the TCM needs to be initialized and/or have the memory reset in accordance with the chart in **Figure 2**. These procedures require use of Toyota's Techstream scan tool or their PC-based version of the scan tool, Techstream lite. This TCM was eliminated on 2012-later models; there is now a pass-through connector that links the transmission connector to the PCM, which also controls the engine.

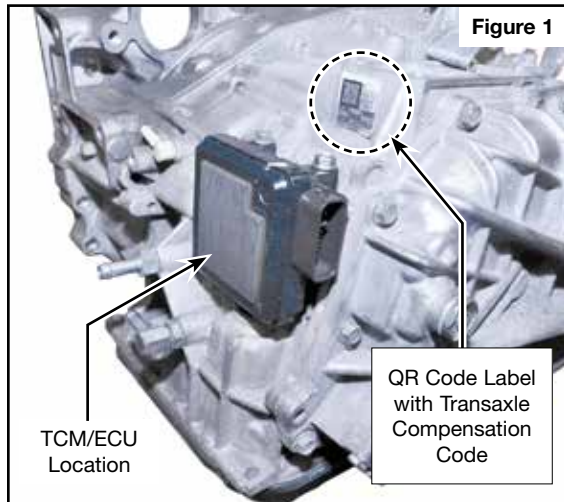

Automatic Transaxle Parts Replacement Chart

Figure 2

Replaced Parts	Transaxle Compensation Code	Road Test	Memory (Learned Values)
Automatic Transaxle Assembly	Input		Reset
Valve Body Assembly	Initialize	Necessary	Reset
Shift Solenoid Valve SL1 and/or SL2		Necessary	
Shift Solenoid Valve SL3 and/or SL4	Initialize	Necessary	Reset
TCM* - Possible	Input (into the new TCM)		
TCM* - Impossible		Necessary	

* **Note:** If possible, read the transaxle compensation code from the previous TCM.

Input Transaxle Compensation Code

The transaxle compensation code is a unique, 60-digit alphanumeric value found on the QR label at the top of the transmission (**Figure 1**). Inputting an incorrect code into the TCM may cause shift shock.

1. Shift the shift lever to Neutral or Park.
2. Connect Techstream to the DLC3 (diagnostic link connector).
3. Turn ignition switch on (do not start the engine).
4. Turn tester on.
5. Enter the menu items in the following order:
Powertrain / ECT / Utility / A/T Code Registration.
6. Select "Set Compensation Code."
7. Register the compensation code:
 - a. Press "Input"
 - b. Type in code. Press "OK."
8. Verify the displayed value is the same as that on the QR label.
9. Press "Next" to set the code to the TCM.

5. Enter the menu items in the following order:
Powertrain / ECT / Utility / A/T Code Reset
6. Press "Next" again to proceed.
7. Press "Exit."

Road Test

1. Warm up the engine.
2. From a standstill, achieve highest possible speed with the accelerator pedal opened no more than 15%. Keep the accelerator pedal angle steady while driving the vehicle.
3. Repeat the previous step until shift shock no longer occurs.
4. From a standstill, achieve highest possible speed with the accelerator pedal opened 25% or more. Keep the accelerator pedal angle steady while driving the vehicle.
5. Repeat the previous step until shift shock no longer occurs.

Memory Reset

This procedure resets the TCM memory so it can memorize new performance information.

1. Turn the ignition switch off.
2. Connect the Techstream to the DLC3.
3. Turn the ignition switch on.
4. Turn Techstream main switch on.
5. Enter the menu items in the following order:
Powertrain / ECT / Utility / Reset Memory.
6. Press "Next" to confirm reset.

Initialize Transaxle Compensation Code

This procedure resets the code and, combined with a road test, allows the TCM to relearn.

1. Shift the shift lever to Neutral or Park.
2. Turn the ignition switch off.
3. Connect Techstream to the DLC3.
4. Turn ignition switch on and push Techstream main switch on.

Figure 3

Clutch & Brake Application							Solenoid Energized When selector position in manually operated.						
Selector Position	C1	C2	B1	B2	B3	F1	SL1	SL2	SL3	SL4	SLU	SLT	SL
P-Park							X					X	
R-Reverse				X	X					X		X	
N-Neutral							X				X		
D, S6-1st	X					X	X					X	
D, S6-2nd	X		X				X		X			X	
D, S6-3rd	X				X		X			X		X	
D, S6-4th	X	X					X	X				X	
D, S6-5th		X			X			X		X		X	
D, S6-6th		X	X					X	X			X	
S1-1st/Manual	X		X			X							

Zip Kit Instructions

1. Valve Body Removal

- With valve body still in transmission, remove 11 indicated bolts (Figure 4).
- Remove case connector and internal wire harness assembly from transmission as part of the valve body.

2. Valve Body Disassembly

- Disconnect and remove counter gear/turbine speed sensor and valve body bolts (Figure 5).
- Disconnect case connector from all seven solenoids. Remove case connector assembly retaining bolt, bracket and connector/harness assembly (Figure 6).
- Remove eight indicated bolts (Figure 8), solenoid brackets, solenoids, small and large cover plate.
- Remove remaining eight bolts (Figure 9).

3. Installation

Install Zip Kit parts as shown on diagram of separate quick guide sheet included in this Zip Kit.



NOTE: Special rebuilding tips for steps 3, 4 and 10 are on page 8 of this booklet.

Sonnax recommends vacuum testing critical wear areas not covered by this kit to determine whether additional Sonnax parts are required (see pages 4–5).

4. Valve Body Reassembly

- Reinstall eight indicated bolts (Figure 9).
- Reinstall solenoid brackets, solenoids, small and large cover plate and eight bolts (Figure 8).
- Reinstall case connector assembly retaining bracket, bolt and connector/harness assembly (Figure 6). Attach wire harness from bracket and connect to all seven solenoids.
- Connect and reinstall counter gear/turbine speed sensor and valve body bolts (Figure 5).

Removal Bolts

Bolt Color Code		Bolt Length
A	Red	25mm
B	Green	30mm
C	Blue	35mm
D	Yellow	45mm
Torque all to 8 ft-lb		

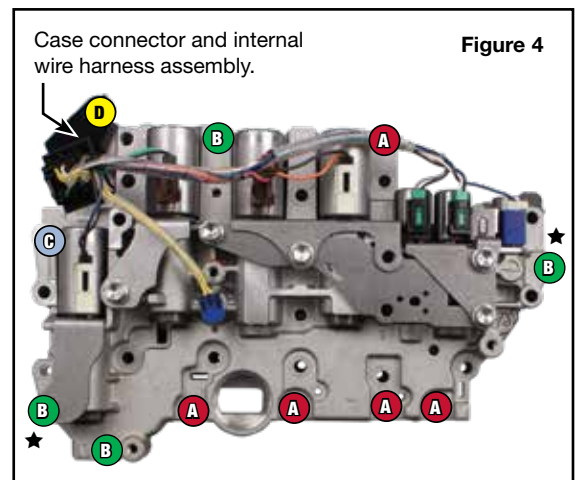

- When reinstalling valve body, first temporarily tighten the two bolts marked (★) in Figure 4 as they are positioning bolts.

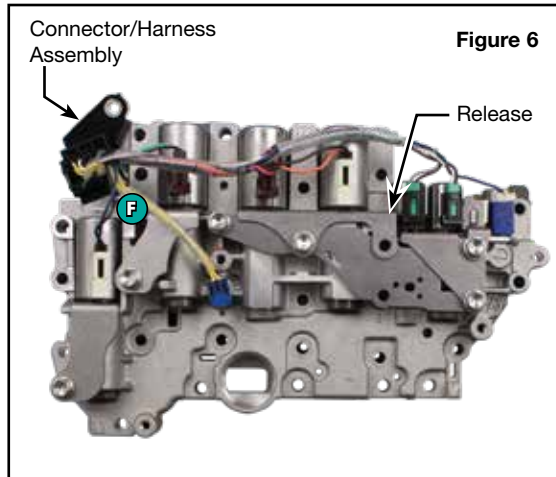
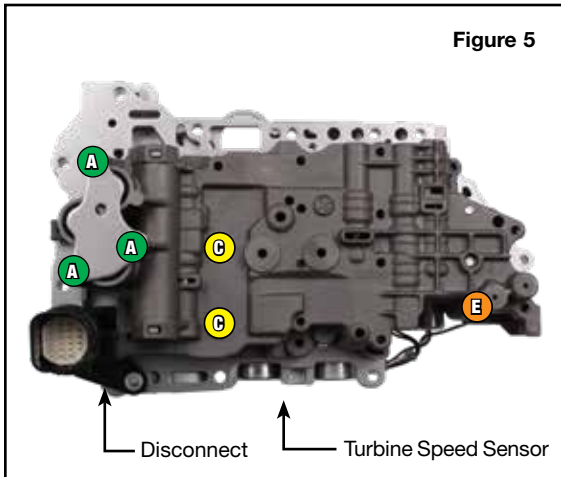

Disassembly & Reassembly Bolts

Bolt Color Code		Bolt Length
A	Green	16mm
B	Purple	35.5mm
C	Yellow	50mm
D	Dk Blue	60mm
E	Orange	70mm
F	Teal	75mm
G	Brown	80mm

Torque all to 8 ft-lb

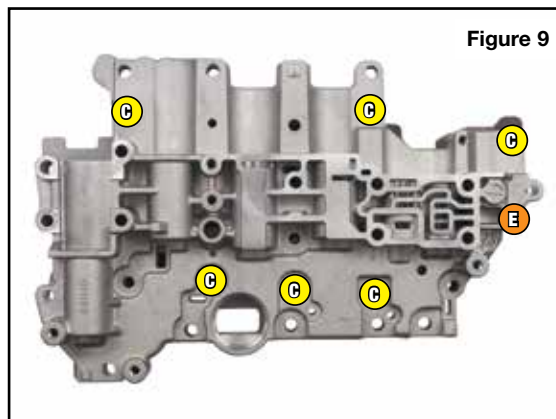
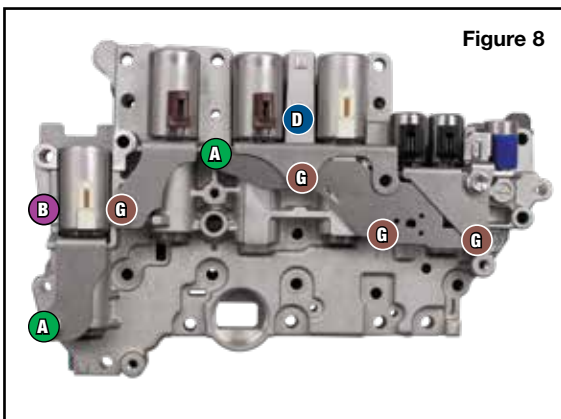
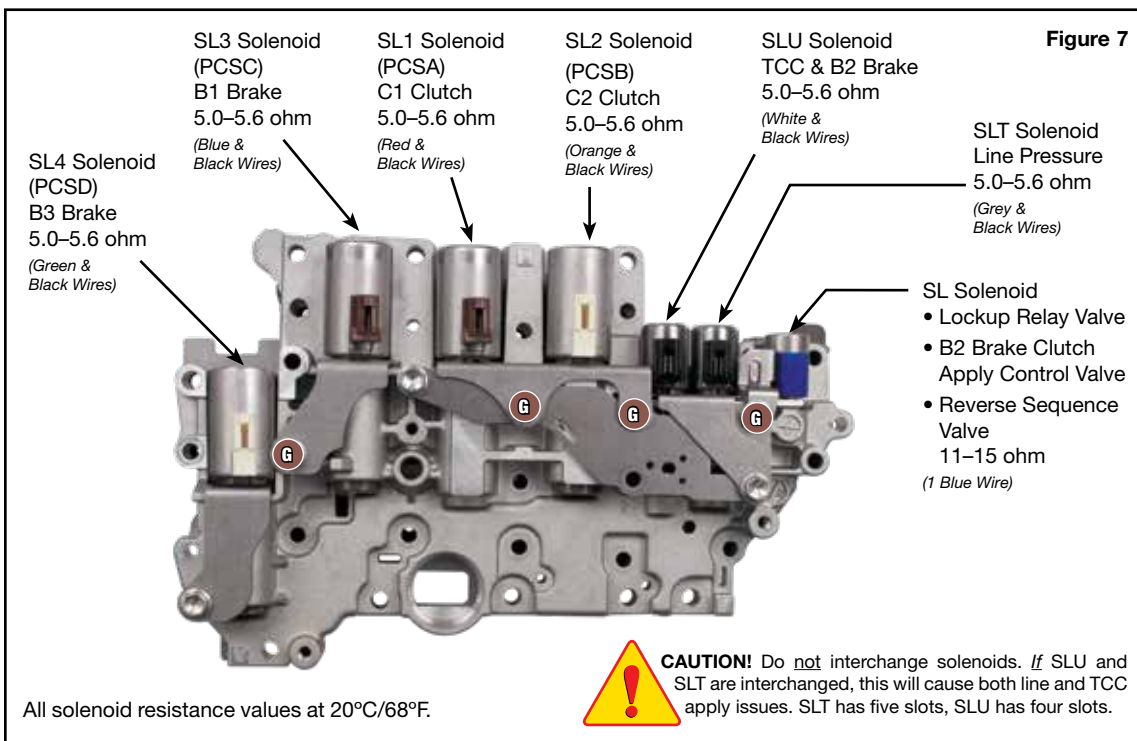

Critical Wear Areas & Vacuum Test Locations

NOTE: OE valves are shown in rest position and should be tested in rest position unless otherwise indicated. Test locations are pointed to with an arrow. Springs are not shown for visual clarity. Low vacuum reading indicates wear and Sonnax parts noted for replacement.

Upper Valve Body • U760E Shown

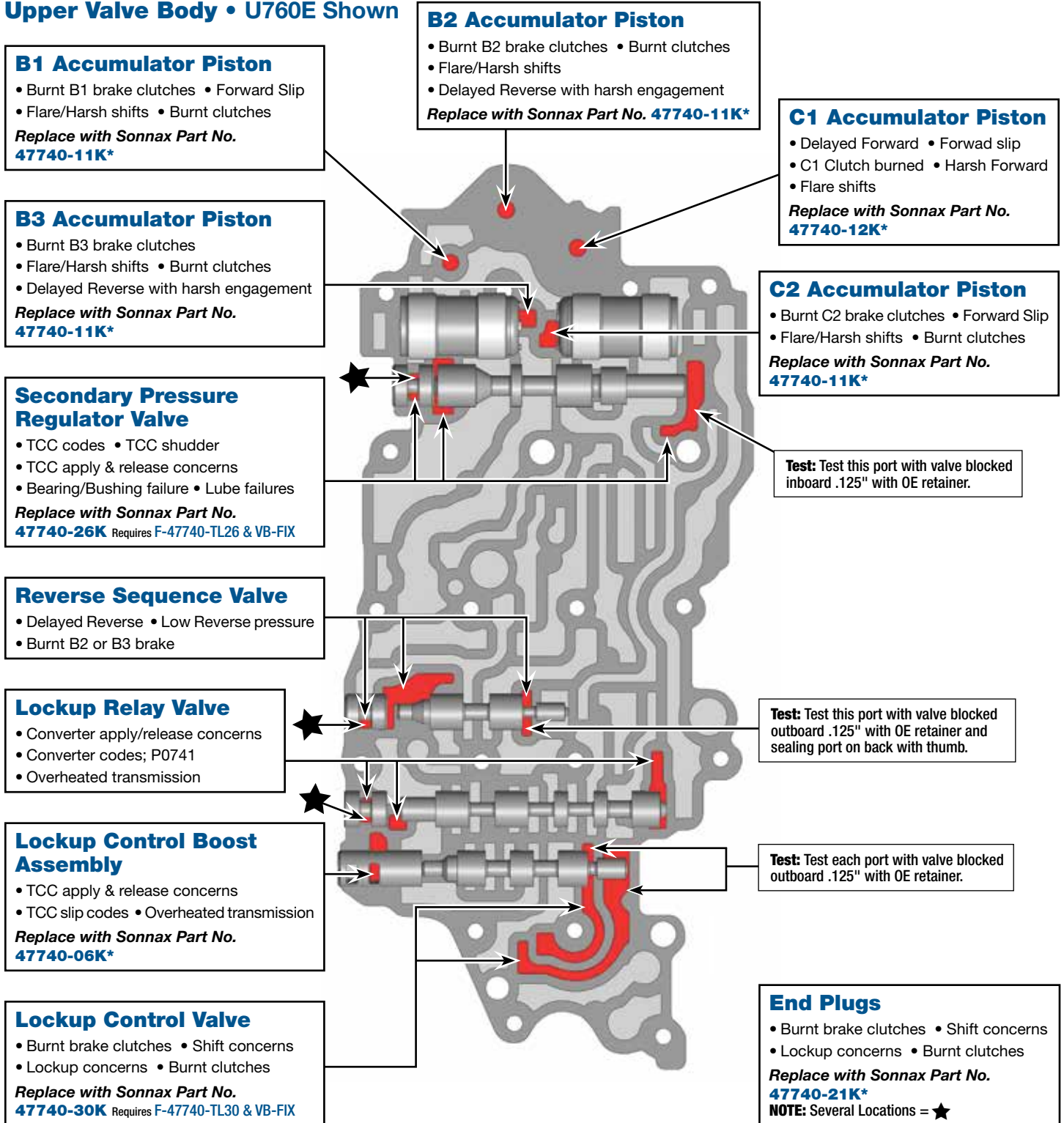

Items with an asterisk () are included in this Zip Kit.



For specific vacuum test information, refer to individual part instructions included in kits and available at www.sonnax.com.

Middle Valve Body – Lower Side, U760E Shown

B1 Apply Boost Assembly

- 1-2 & 5-6 Flare • Gear ratio codes
- B1 brake clutches burned • Bind-up
- No Manual 1st • 2nd & 6th Slip

Replace with Sonnax Part No. **47740-40K***

Test: Block this port and port on back when testing.

B1 Apply Control Valve

- 1-2 Long slide • Low line pressure
- Clutch failure • B1 brake clutches burned

Replace with Sonnax Part No. **47740-44K** Requires F-47740-TL44 & VB-FIX

Primary Pressure Regulator Valve

- Erratic/Soft/Harsh shifts • Low line pressure/rise
- Clutch slippage • High line pressure in Reverse
- High line pressure • Burnt clutches
- Burnt brake clutches
- Low converter pressure

Replace with Sonnax Part No. **47740-02K** Requires F-47740-TL2 & VB-FIX

Note: Seal port on back when testing.

Test: Test this port with valve blocked inboard .218" dia. checkball.

Clutch Control Valve

- 4-5 Flare/Harsh
- Delayed Neutral to Drive
- Delayed Reverse

Replace with Sonnax Part No. **47740-22K** Requires F-47740-TL22 & VB-FIX

Sequence Valve

- Shift concerns • Burnt clutches/brakes

B2 Apply Control Valve

- B2 Clutch burned
- Delayed Reverse
- No Reverse
- Reverse slip

Replace with Sonnax Part No. **47740-27K** Requires F-47740-TL27 & VB-FIX

Note: Seal port on back when testing.**

C2 Clutch Apply Control Valve

- Slipping 4th, 5th, 6th
- Burnt C2 clutch

Test: Test this port and port on back when testing B2 apply control valve.**

B2 Control Valve

- Delayed/Harsh Reverse
- Double bump Reverse engagement
- No Manual 1st
- B2 Brake clutches burned

Replace with Sonnax Part No. **47740-35K** Requires F-47740-TL35 & VB-FIX

Solenoid Modulator Valve

- Shift concerns
- Solenoid performance codes
- TCC apply & release concerns

Replace with Sonnax Part No. **47740-25K** Requires F-47740-TL24 & VB-FIX

Note: Seal when testing B1 apply boost assembly.

Reverse Boost Assembly

- Delayed Reverse • Reverse slip
- Low line rise in Reverse • No Reverse
- B2 Brake clutches burned
- UD/B3 Brake clutches burned
- Low Reverse boost • B4 Clutch burned

Replace with Sonnax Part No. **47740-38K***

Middle Valve Body – Back Side, U760E Shown

Note: Seal when testing B1 apply control valve.

Note: Seal when testing pressure regulator valve.

Note: Seal when testing B2 apply control valve.**

** These two passages are connected. The mat will provide the seal for the middle valve body, upper side. The passage indicated (**) will also need to be sealed to vacuum test the circuit.

Items with an asterisk () are included in this Zip Kit.

OE Exploded View

Upper Valve Body • U760E Shown

NOTE: Depending upon vehicle application, the OE springs shown may not be present.

Upper Valve Body Descriptions

I.D. No.	Description
101	Lockup Control Valve (inboard) Lockup Control Boost Assembly (outboard)
102	Lockup Relay Valve
103	Reverse Sequence Valve
104	Secondary Pressure Regulator Valve
105	B3 Accumulator Piston
106	B1 Accumulator Piston
107	B2 Accumulator Piston
108	C1 Accumulator Piston
109	C2 Accumulator Piston
110	Lube Relief Check Valve
111	Converter Relief Check Valve

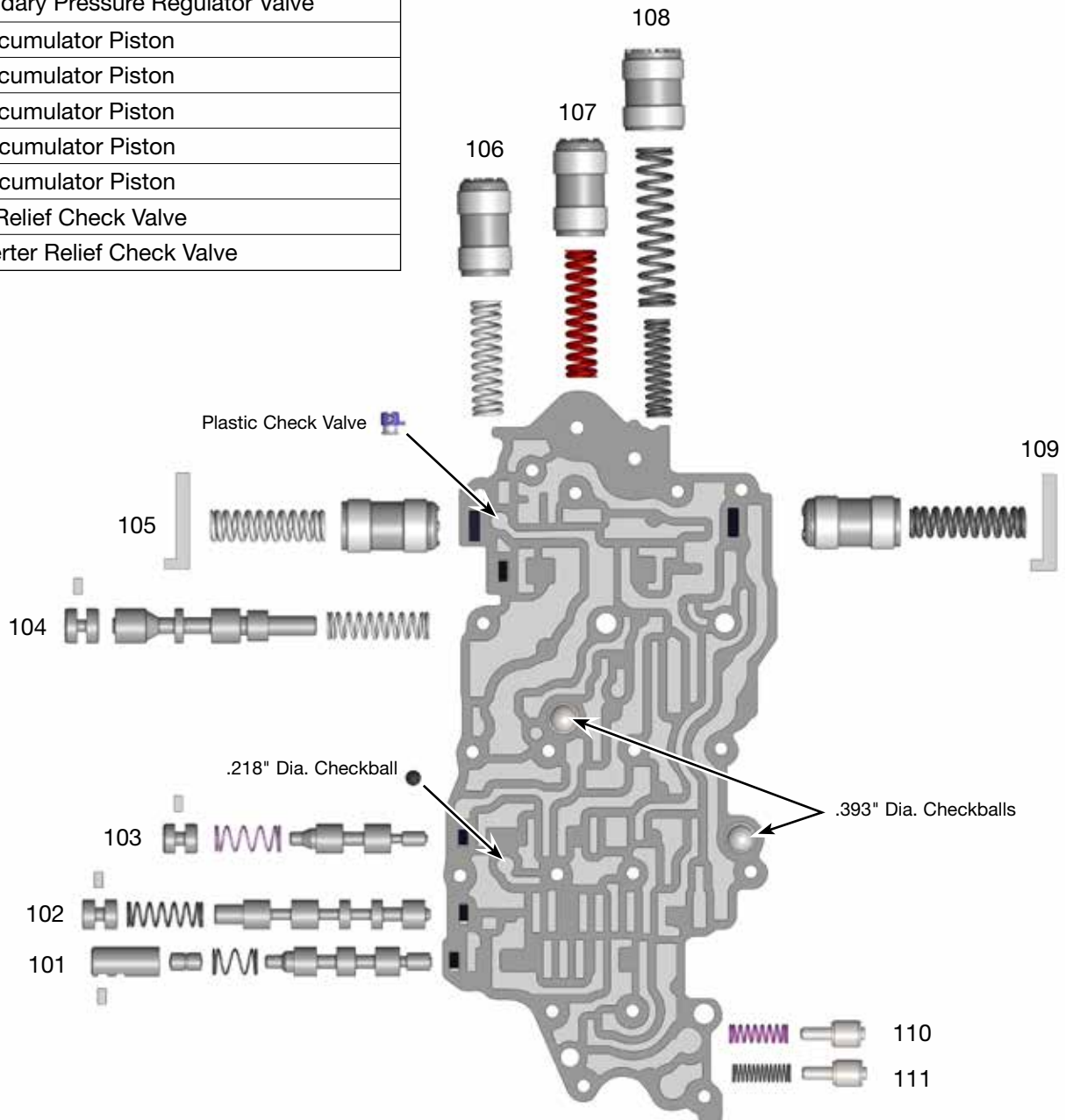

Middle Valve Body • U760E Shown

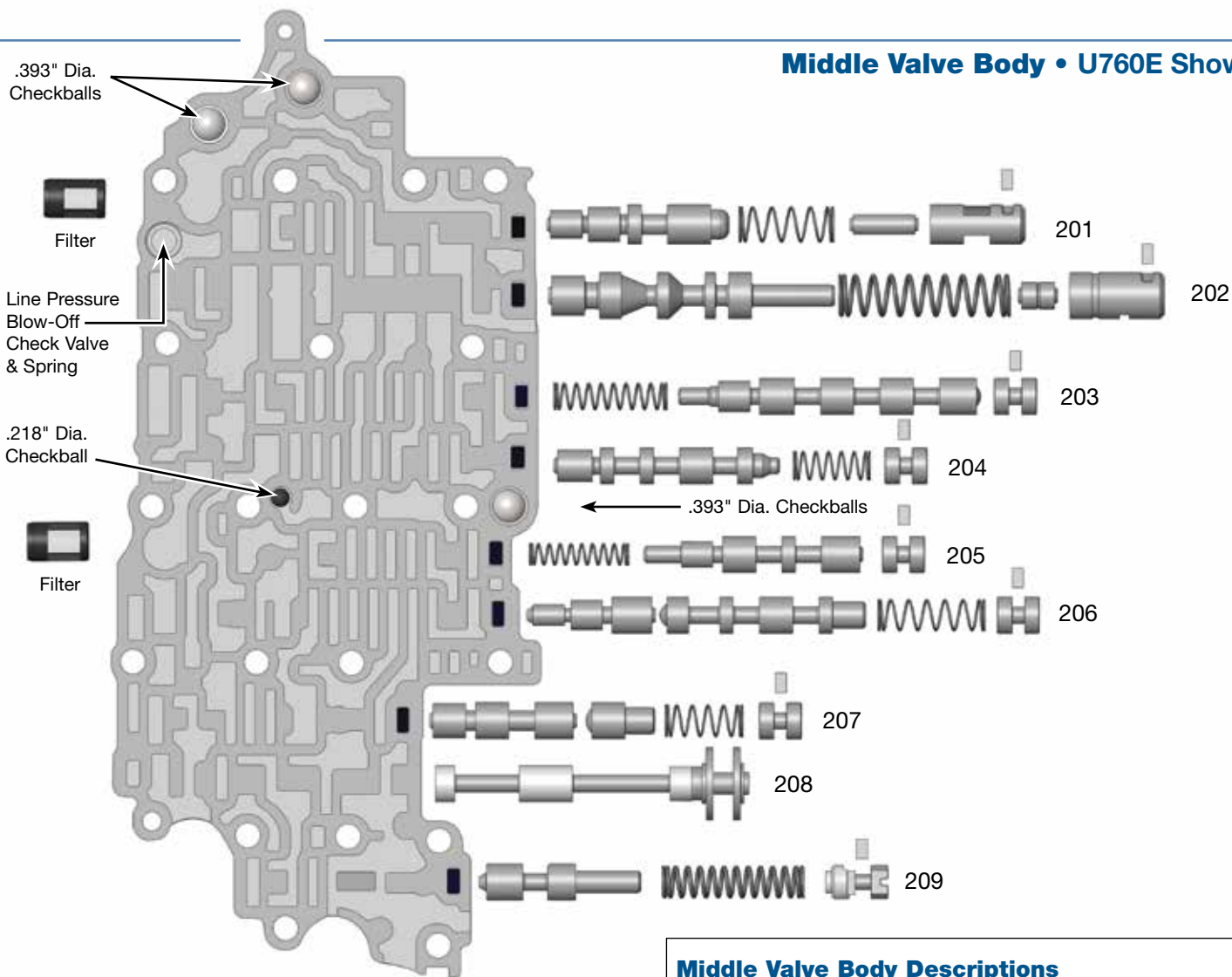

Middle Valve Body Descriptions	
I.D. No.	Description
201	B1 Apply Control Valve (inboard) B1 Apply Boost Assembly (outboard)
202	Primary Pressure Regulator Valve (inboard) Reverse Boost Assembly (outboard)
203	Sequence Valve
204	Clutch Control Valve
205	C2 Clutch Apply Control Valve
206	B2 Apply Control Relay Valve (inboard) B2 Apply Control Valve (outboard)
207	B2 Control Valve (inboard) B2 Control Relay Valve (outboard)
208	Manual Valve
209	Solenoid Modulator Valve

Additional Technical Tips for Installation Steps 3, 4 & 10 from the Quick Guide

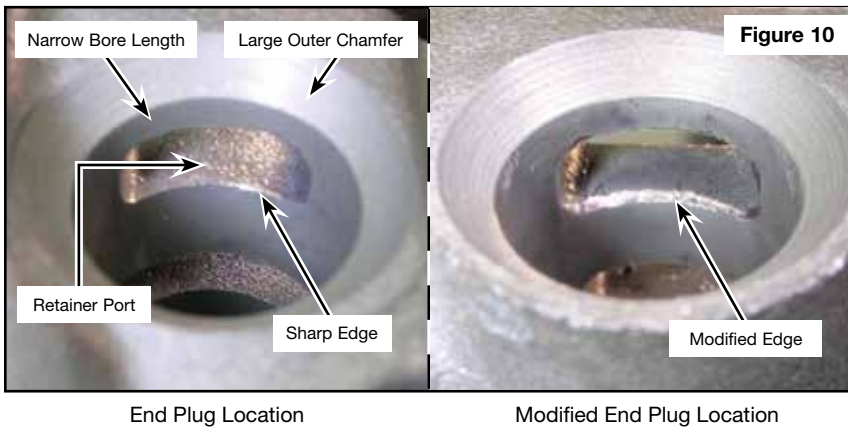

Step 3 Replace OE Small End Plugs

The large outer chamfer on the small end plug bores makes the outer bore too narrow for an O-ring to seal properly. Sonnax O-ringed end plugs require the O-ring to seal at the bore inboard of the retainer port. To prevent O-ring shear during assembly, the sharp edge must be broken. This can be done by inserting a narrow file or small screwdriver through the retainer port and reworking the edge (**Figure 10**).

To install O-ringed end plug after the edge has been modified, place O-ring in the narrow plug groove. Lubricate plug and O-ring with O-Lube and roll on bench to size. Carefully push plug into the bore. As O-ring contacts the modified edge, gently compress exposed portion with a small screwdriver blade inserted through retainer port.

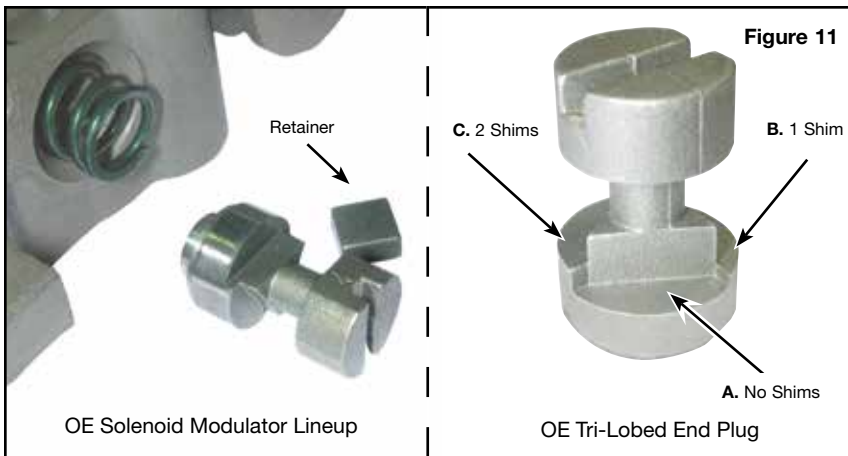

Step 4 Replace OE Solenoid Modulator Valve Lineup

 During disassembly of OE solenoid modulator lineup, note location of the tri-lobed end plug (if applicable) retainer (**Figure 11**). This adjusts solenoid modulator pressure. Follow options A-D if a tri-lobed end plug is used.

If a standard two-spooled end plug is used, proceed to option E.

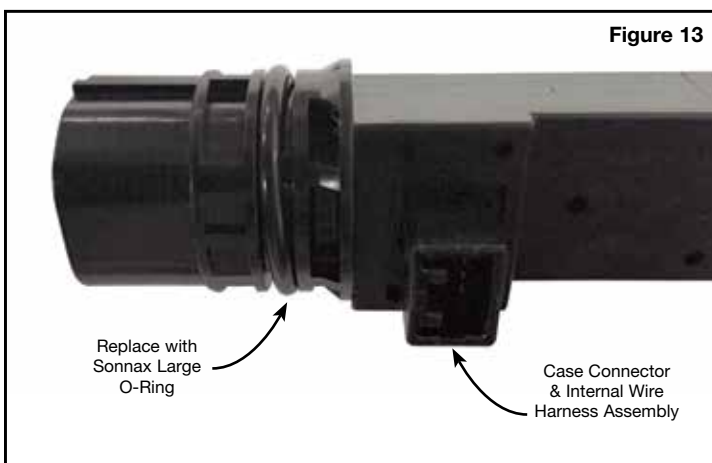
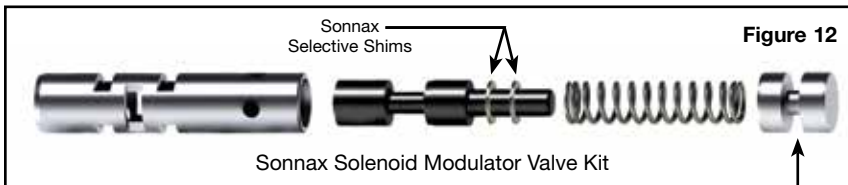

- Option A:** If OE retainer is installed at the most narrow location, no Sonnax shims are required.
- Option B:** If OE retainer is installed at the middle spool location, one Sonnax shim is required.
- Option C:** If OE retainer is installed at the widest spool location, two Sonnax shims are required.
- Option D:** Shims should be placed over valve spring stem, between valve spool face and spring (**Figure 12**).
- Option E:** For standard two-spooled OE plug, do not use any shims. Install as pictured (**Figure 12**), omitting the shims.

NOTE: Sonnax end plug can be swapped end for end for best fit of sleeve in bore.

Step 10 Replace OE O-Ring on Case Connector

Replace O-ring in the case connector and internal wire harness assembly (**Figure 13**).